

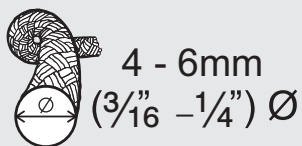

# CL826-xx Aero cleat Instructions

Compact cleats that are rigged on a rope. Nylon and alloy versions. Easy to rig and adjust. Strong and wear resistant. Ideal for forestay tensioning, kitesurfing, sports netting, sun sails, canvas structures, tie-downs, radio masts and aerials.



**CL826-11**

CL826 Aero base with alloy CL211 Mk2, silver 34gm. 1.2oz.

**CL826-11AN**

CL826 Aero base with alloy CL211 Mk2, hard anodised 34gm. 1.2oz.

**CL826-72**

CL826 Aero base with black nylon CL272, Mk2 Junior 23gm. 0.8oz.

Standard rigging for all cleats  
2:1 advantage

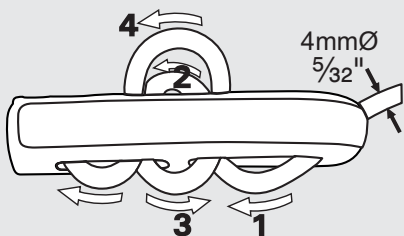
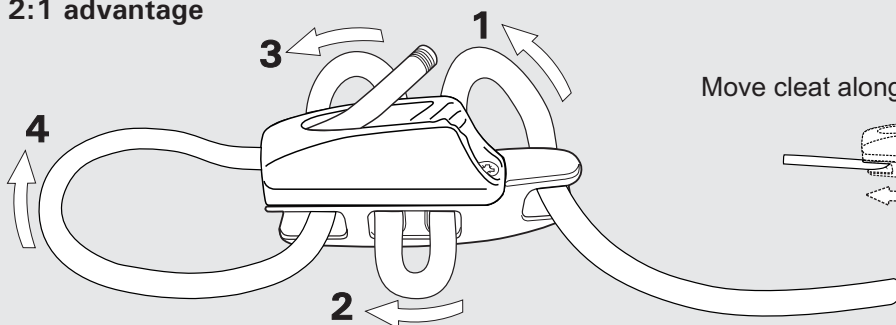

When using 4mm rope, take an extra turn round centre pillar.



Move cleat along the rope by hand. No tools required.

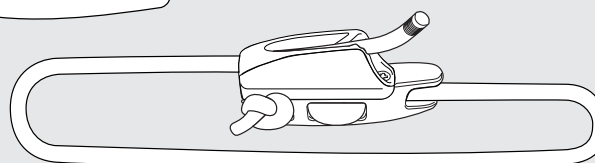
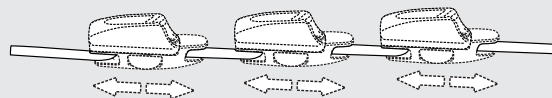

Rig like this to make a loop.

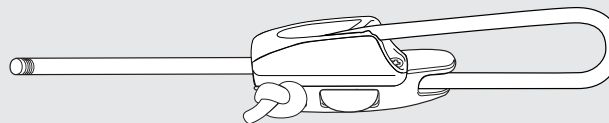

Rigging like this = no rope tail.

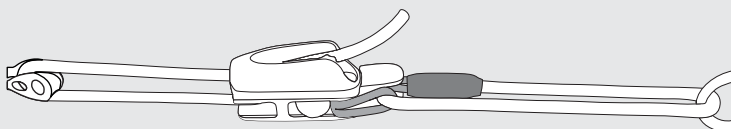

Can be rigged like this using a stop.

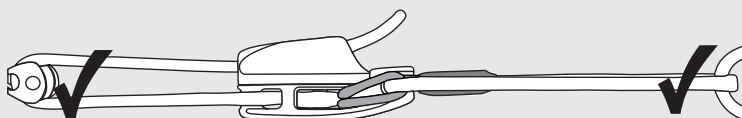

Rope ends should be at right angles.

